

Wilson Energy Ltd



Today's energy partner for tomorrow's world

Wilson **W1**

Electronic Twin Plate HIU



Data Sheet

Wilson Energy Limited

Unit 7 | Mayden Business Park Northern Road | Newark | Nottinghamshire | NG24 2EU

Tel: **01636 857240** Email: enquiries@wilsonenergy.co.uk

Web: www.wilsonenergy.co.uk



ADVANTAGES

- Combined, prepared connection of radiators and underfloor heating systems
- Highly convenient domestic hot water supply
- Billing for cold water and energy costs as required
- Compact design
- BESA approval pending
- Market leading overall VWART figures
- Billing of energy consumption

Compact and connection-ready, this all-in-one heat interface unit offers indirect heat transfer to the heating and DHW systems.

DESCRIPTION

The compact electronic heat interface unit is designed as an indirect transfer unit for supplying heat and serving dual purposes: decentralised DHW heating based on the instantaneous water heating principle and decentralised indirect heat distribution in residential units. With various hydraulic components available for selection, the unit ensures on-demand DHW heating, distribution of heat energy as well as calculation of energy costs.

INSTALLATION POSITION

This electronic HIU is suitable for surface mounting and can be installed in pantries, storerooms, etc. Ideally, it should be located close to the domestic hot water draw-off points for each apartment. Can be installed in utility cupboards, closets, storerooms etc.

OPERATING PRINCIPLE

The HIUs in the electronic series are designed for DHW heating and indirect heat distribution in multi-storey residential buildings. They utilise primary energy supplied via a central buffer cylinder; DHW is generated in the domestic hot water PHEX as required, according to the instantaneous water heating principle. Via the additional indirect heating circuit connection, the heating surfaces in the living space can be connected to underfloor heating circuit manifolds or radiators. The modules come with fittings ready for the installation of heat meters.

BUILDING CATEGORIES

- Detached houses
- Apartment buildings
- Student accommodation
- Care Homes
- Extra Care facilities

SYSTEM/BASIC DIAGRAM

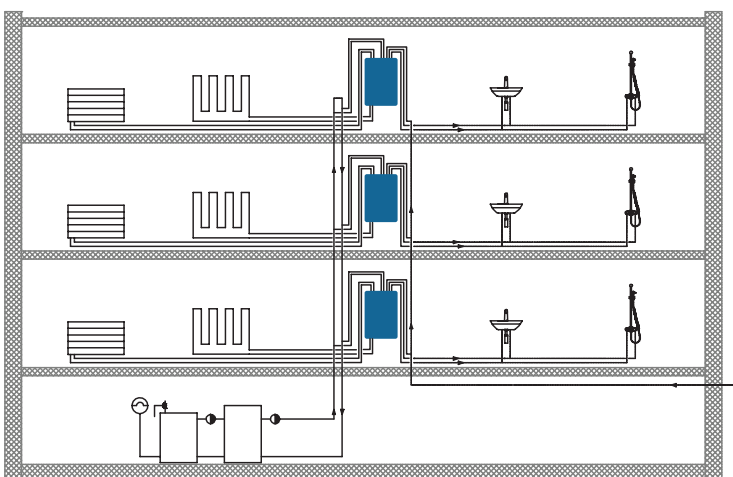

SPECIFICATION

General

- Operating pressure $P_{O,max}$ primary: 6bar, 16 bar on request
- Overall dimensions: W 455 mm x H 767.5 (830.5) mm x D 300 mm
- Weight without water: appr. 30 kg

Primary Supply

- Operating temperature $T_{O,max}$: 90 °C
- Operating pressure: $P_{O,max}$: 10 bar (on request: 16 bar)
- DPCV: 5-50 kPa ; 15-1500 l/h
- Max. differential pressure Δp primary: 1000 mbar
- Heatmeter M Bus:

Secondary Heating

- Operating temperature $T_{O,max}$: 85 °C
- Operating pressure $P_{O,max}$: 2.5 bar
- Safety valve: 2.5 bar
- Highly efficient circulation pump: TacoFlow2 (EEI ≤ 0,20-Part 2)
- Expansion vessel volume: 10 l

Domestic hot / cold water

- Operating temperature $T_{O,max}$: 60 °C
- Operating pressure $P_{O,max}$: 9.5 bar

Material

- Heat exchanger: copper brazed
- Cover: EPP insulation
- Pipes: DN 20, stainless steel 1.4404
- Pump body: composite
- Valve body: brass
- Seals: AFM 34 (flat-sealing)

Output data

- See design diagram

Electrical connection information

- Protection class: IP40
- Rated voltage: 230 VAC +/- 10%
- Frequency: 50/60 Hz

Power consumption

- Power consumption: max 50 W

Flow media

- Heating water (VDI 2035; SWKI BT 10201; ÖNORM H 5195-1)
- Cold water to DIN 1988200 and DIN EN 8065

APPROVALS / CERTIFICATES

- Components in contact with drinking water comply with UBA Evaluation Criteria 26/03/2018 and Directive (EU) 2015/1535

TYPE OVERVIEW

WilSon W1 | Electronic heat interface unit

Part no.	DN	Rp	Number of plates for heating/DHW
W1-H10-D26	20	3/4"	10 / 26
W1-H10-D40	20	3/4"	10 / 40
W1-H10-D50	20	3/4"	10 / 50
W1-H16-D26	20	3/4"	16 / 26
W1-H16-D40	20	3/4"	16 / 40
W1-H16-D50	20	3/4"	16 / 50
W1-H26-D26	20	3/4"	26 / 26
W1-H26-D40	20	3/4"	26 / 40
W1-H26-D50	20	3/4"	26 / 50
W1-H40-D26	20	3/4"	40 / 26
W1-H40-D40	20	3/4"	40 / 40
W1-H40-D50	20	3/4"	40 / 50
W1-H10-D70	20	3/4"	10 / 70
W1-H16-D70	20	3/4"	16 / 70
W1-H26-D70	20	3/4"	26 / 70
W1-H40-D70	20	3/4"	40 / 70

DIMENSIONAL DRAWING

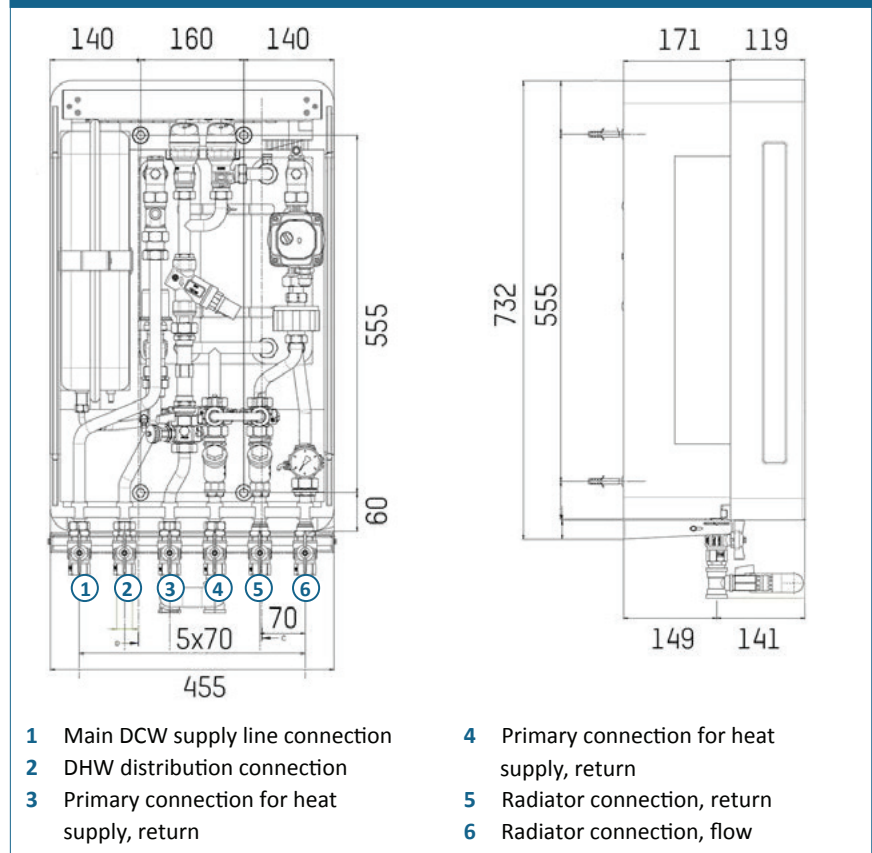

- | | |
|--|--|
| 1 Main DCW supply line connection | 4 Primary connection for heat supply, return |
| 2 DHW distribution connection | 5 Radiator connection, return |
| 3 Primary connection for heat supply, return | 6 Radiator connection, flow |

FLOW DIAGRAM

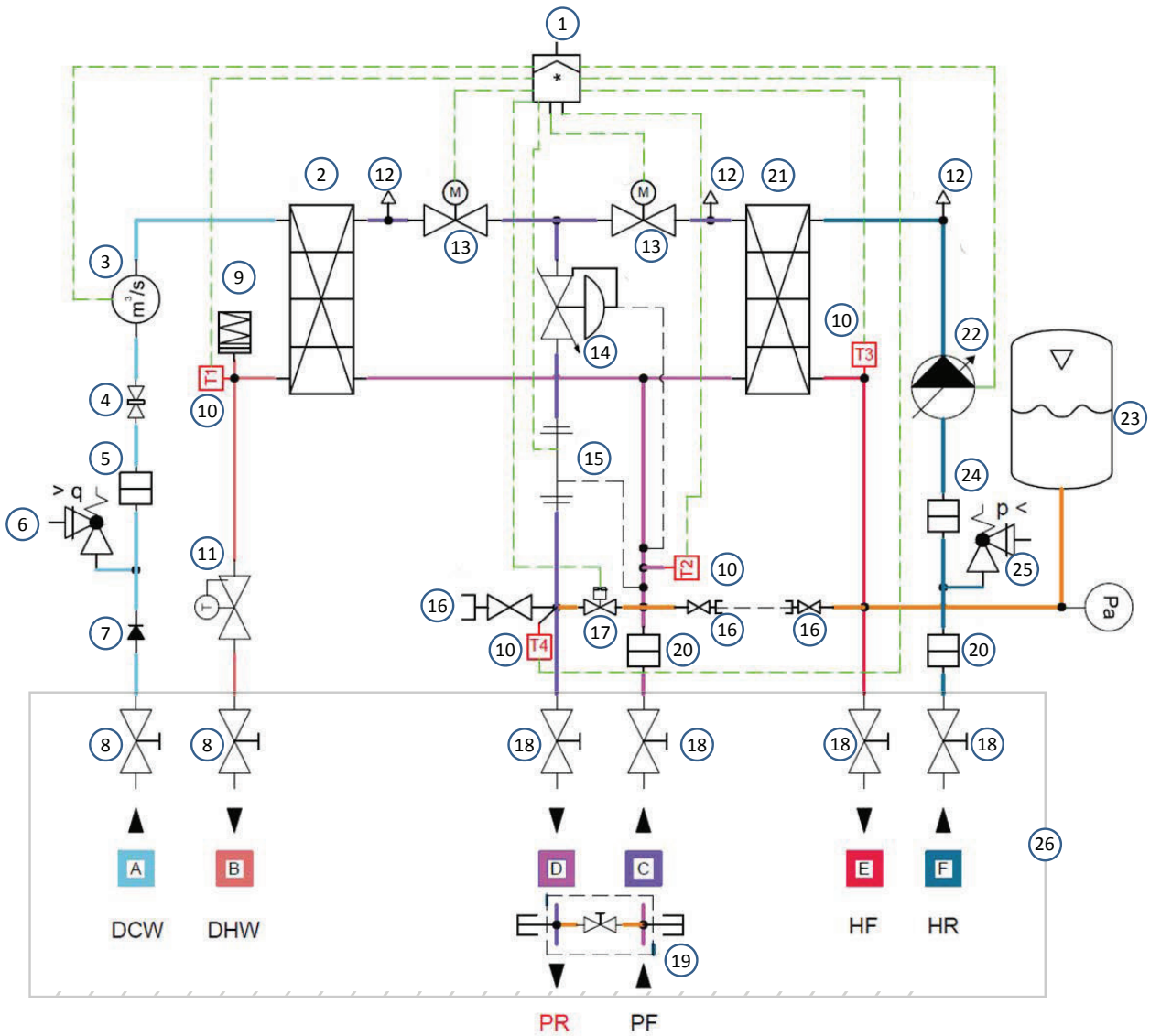

1 Z1 Control Unit

Domestic hot / cold water circuit

- A District Cold water inlet
- B District Hot water outlet
- 2 PHE – DW
- 3 Flow sensor
- 4 Flow limiter (optional)
- 5 Filter
- 6 Safety valve (optional)
- 7 Check valve
- 8 Stop valve (optional with Fixrail)
- 9 Water hammer arrester
- 10 Temperature sensor NTC10K
- 11 Thermic safety valve (optional)

Primary circuit

- C Primary Buffer flow
- D Primary Buffer return
- 12 Vent
- 13 Control valve
- 14 Differential pressure control valve
- 15 Heatmeter
- 16 Fill- / Flush- / Drain valve
(Pressure test point)
- 17 2 way zone valve with actuator
- 18 Stop valve (optional with Fixrail)
- 19 Flushing bypass
(option in connection with Fixrail)
- 20 Strainers

Heating circuit

- E Heating flow
- F Heating return
- 21 PHE – SH
- 22 Circulation pump
- 23 Diaphragm type expansion tank
- 24 Magnet separator (optional)
- 25 Safety valve
- 26 Fixrail (accessory - containing 8/18/19)

**FLOW AND PRESSURE LOSS DIAGRAMS
PLATE HEAT EXCHANGER WITH 26 PLATES (DOMESTIC HOT WATER)**

Performance

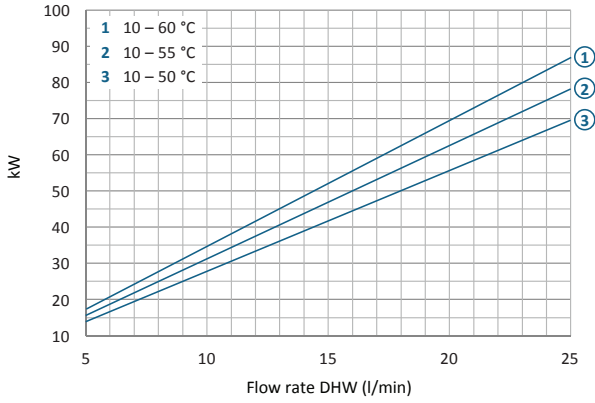

Volume flow DHM primary / performance

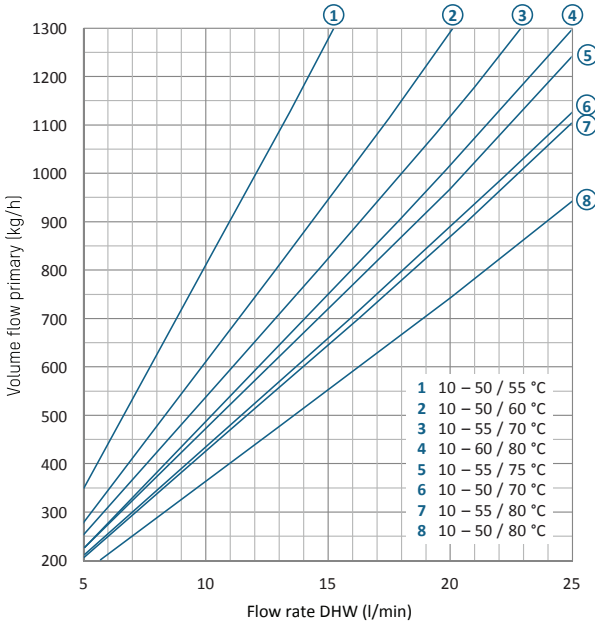

Pressure loss primary with heatmeter

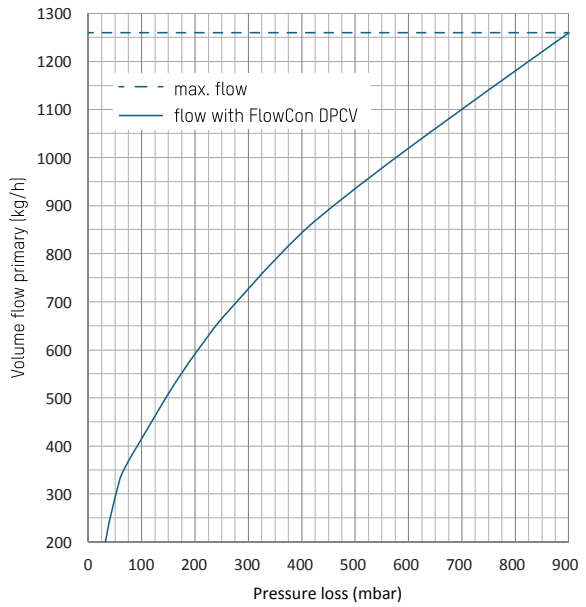

Return temperature

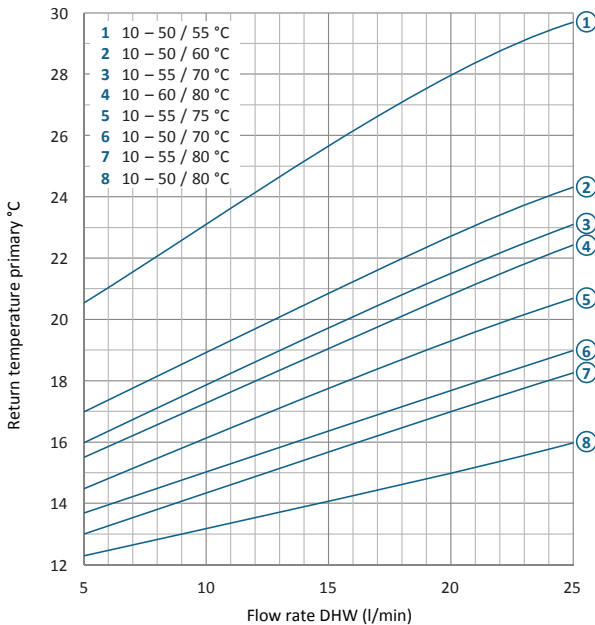

Pressure loss DHW secondary

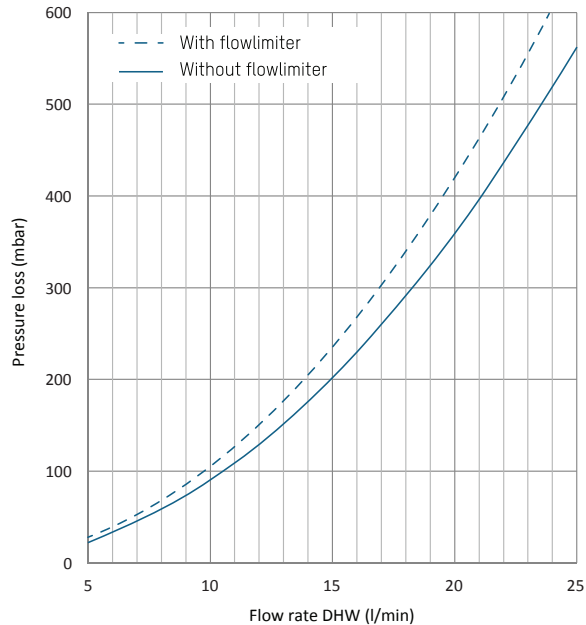

FLOW AND PRESSURE LOSS DIAGRAMS PLATE HEAT EXCHANGER WITH 40 PLATES (DOMESTIC HOT WATER)

Performance

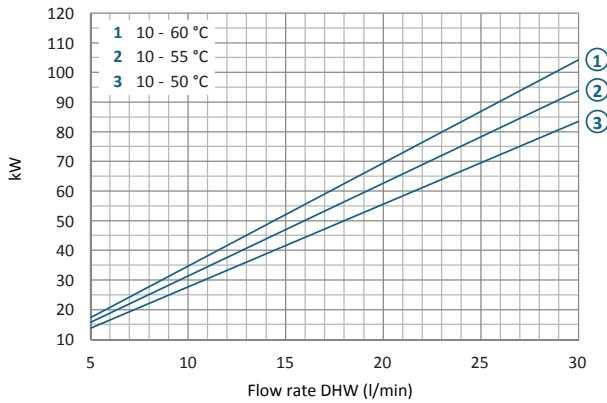

Volume flow DHM primary / performance

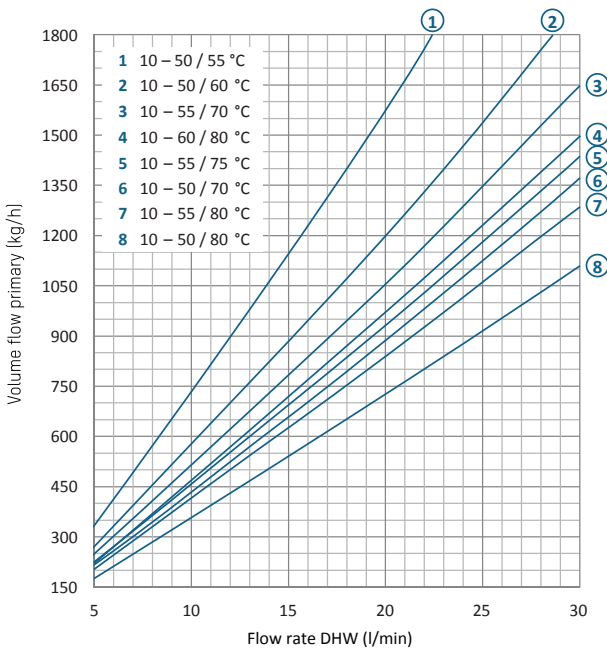

Pressure loss primary with heatmeter

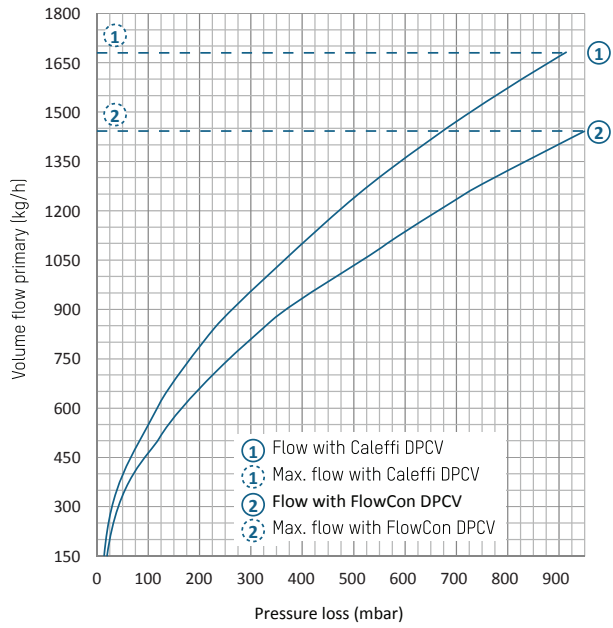

Return temperature

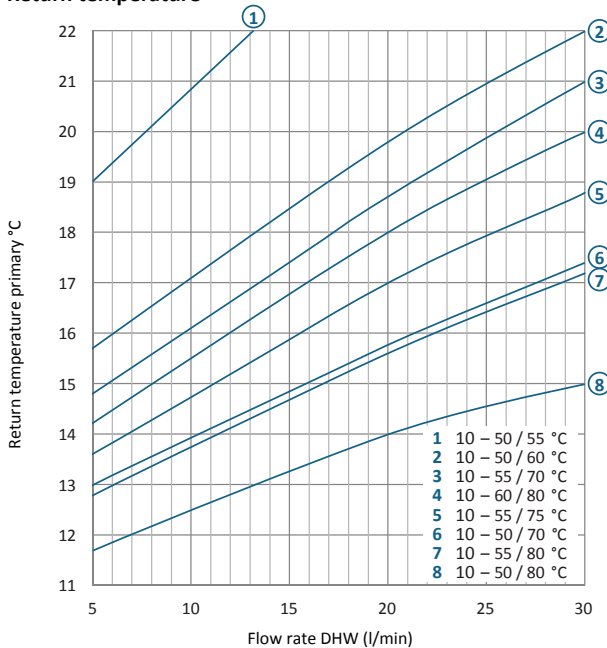

Pressure loss DHW secondary

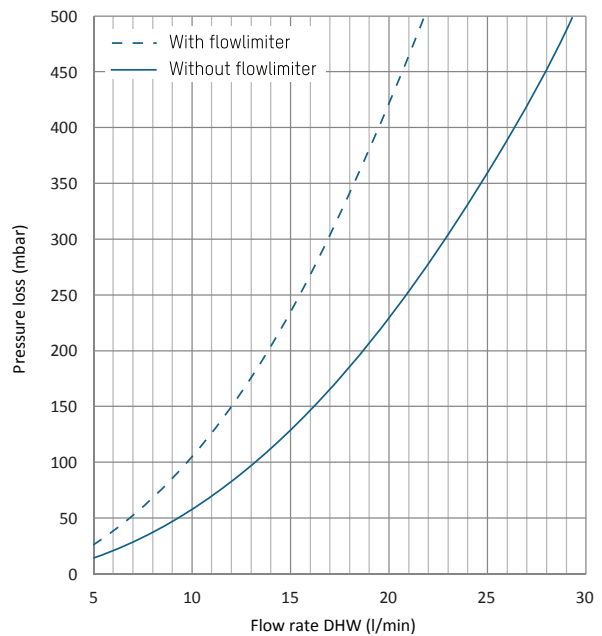

FLOW AND PRESSURE LOSS DIAGRAMS PLATE HEAT EXCHANGER WITH 50 PLATES (DOMESTIC HOT WATER)

Performance

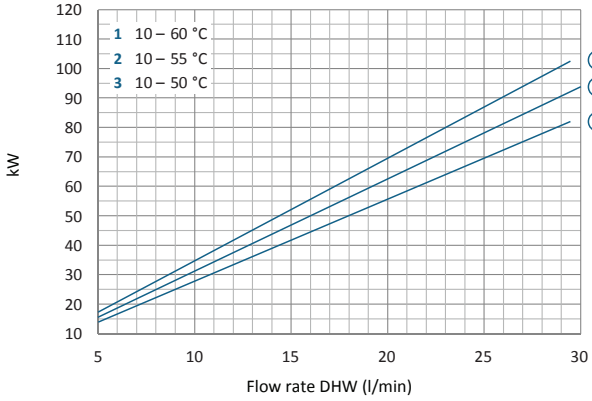

Volume flow DHM primary / performance

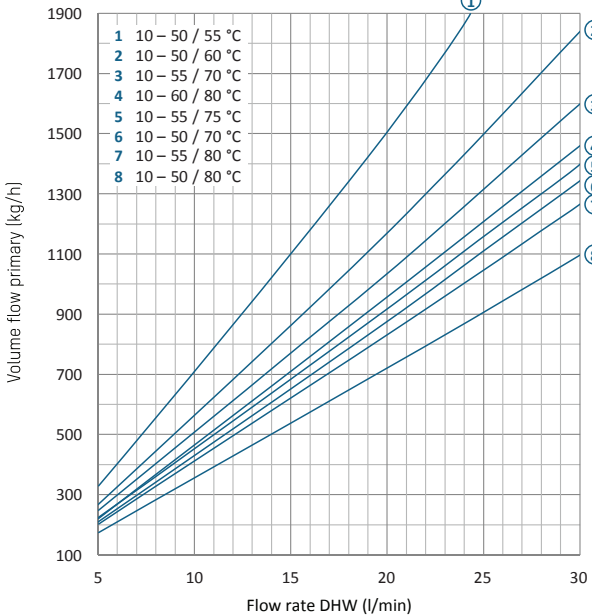

Pressure loss primary with heatmeter

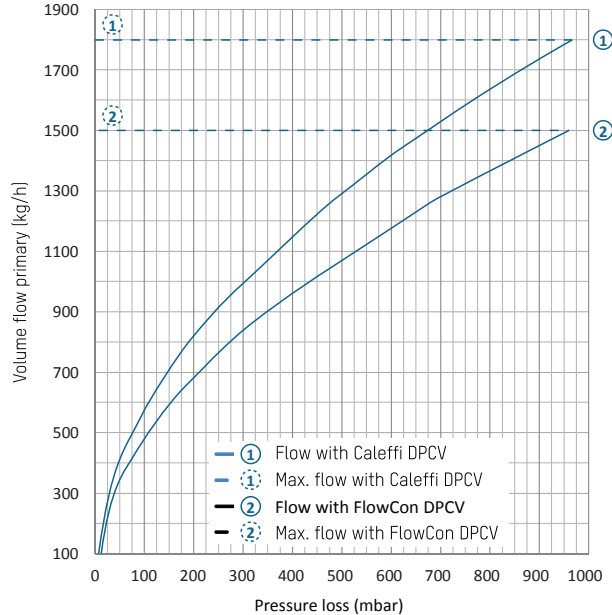

Return temperature

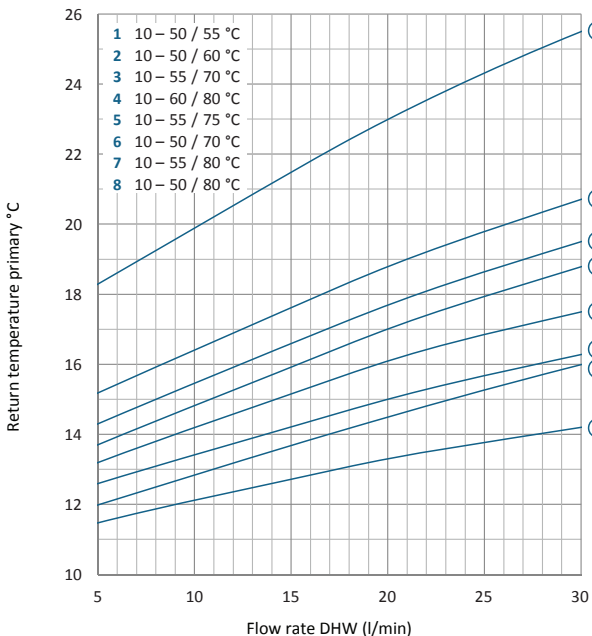

Pressure loss DHW secondary

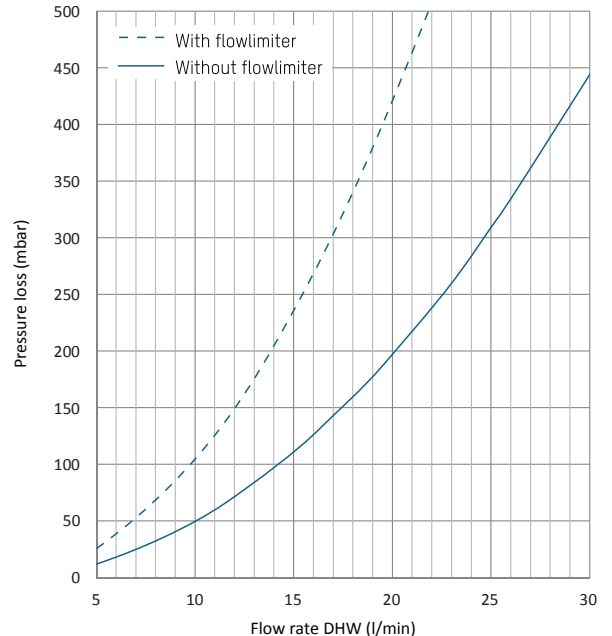

FLOW AND PRESSURE LOSS DIAGRAMS PLATE HEAT EXCHANGER WITH 70 PLATES (DOMESTIC HOT WATER)

Performance

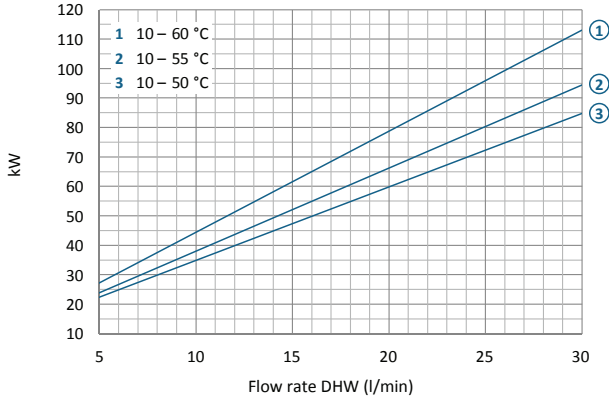

Volume flow DHM primary / performance

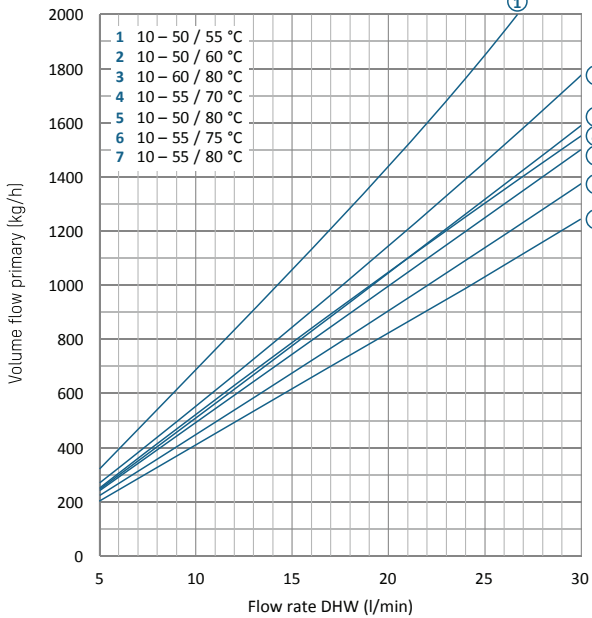

Pressure loss primary with heatmeter

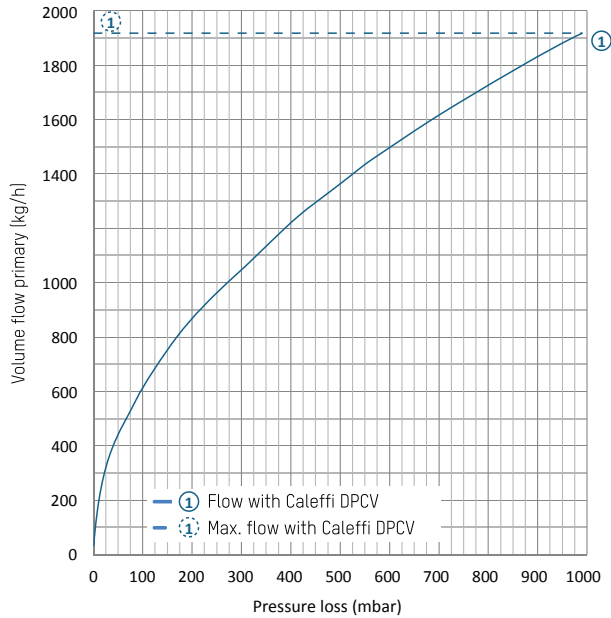

Return temperature

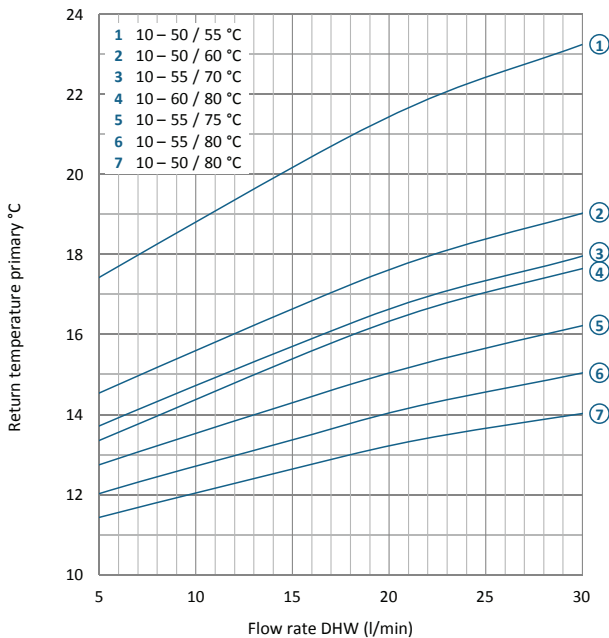

Pressure loss DHW secondary

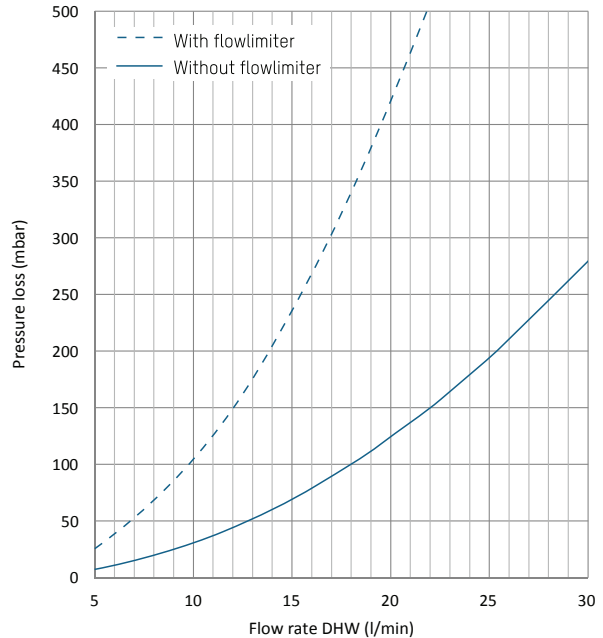

EXAMPLE OF INTERPRETING THE FLOW RATE AND PRESSURE LOSS DIAGRAMS

Given

- Performance: 4 kW
- Temperature Building primary: 75°C
- Temperature Heating primary: 70 °C
- Temperature Heating Return:40 °C

Wanted

- 1 Size of the PHE
- 2 Specific values to match performance

Solution:

1 Table A) determines the size of the PHE. For this purpose, the desired performance value 4 kW must be smaller than the maximum performance values of the PHE at the corresponding temperatures (75°C / 70°C / 40°C).

--> The 10 plates heat exchanger fits.

2 To find the specific values matching to the desired performance of 4 kW go to the diagrams B), C) and D).

▪ In diagram B) the volume flow of heating secondary at the intersection point of the performance of 4 kW and the temperature difference of 30K (70°C - 40°C) is 115 kg/h.

▪ In diagram C) the secondary pressure loss for the secondary volume flow demand of 115 kg/h is 27 mbar. The pump head is 193 mbar, so the residual pump head is 166 mbar (Δp) (193-27=166).

▪ The primary volume flow must be calculated using the maximum performance (8.7 kW) and flow rate (q=278 kg/h) from Table A) and the desired performance (4 kW).

$$\frac{\text{Performance}}{\text{max. Performance}} * q_{\text{primary.max}} = q$$

$$\frac{4 \text{ kW}}{8.7 \text{ kW}} 278 \frac{\text{kg}}{\text{h}} = 28 \frac{\text{kg}}{\text{h}}$$

▪ In diagram D) the primary pressure loss at the intersection point of the calculated primary volume flow (128 kg/h) and the curve of the 10 PHE is 105 mbar.

▪ The specific values for 10PHE at 4kw are:

- a $q_{\text{prim.}}: 128\text{kg/h}$, $dp_{\text{prim.}}: 105\text{mbar}$
- b $q_{\text{sec.}}: 115\text{kg/h}$, $dp_{\text{sec.}}: 27\text{mbar}$

**FLOW AND PRESSURE LOSS DIAGRAMS
PLATE HEAT EXCHANGER WITH 10, 16 AND 26 PLATES (HEATING MODULE)**

A Values of the heat exchangers at maximum performance.

Building primary °C	Heating Primary °C	Heating Return °C	10 plates				16 plates				26 plates			
			prim				prim				prim			
			Max. Performance kW	Return Temperature °C	Pressure loss mbar	Flowrate q kg/h	Max. Performance kW	Return Temperature °C	Pressure loss mbar	Flowrate q kg/h	Max. Performance kW	Return Temperature °C	Pressure loss mbar	Flowrate q kg/h
75	70	40	8.7	48	229	278	12.5	47	152	386	27.8	48	447	889
	65	35	8.7	40	136	214	12.5	39	92	300	27.8	40	266	686
70	65	35	8.7	43	229	278	12.5	42	152	386	27.8	43	447	889
	60	30	8.7	33	122	203	12.5	35	97	309	27.8	36	282	706
65	60	40	5.8	44	169	238	8.4	44	120	343	18.6	44	328	762
		30	8.7	39	247	288	12.5	38	163	400	27.8	38	447	889
	55	35	5.8	38	102	185	8.4	38	73	267	18.6	38	199	593
60	55	35	5.8	40	186	250	8.4	39	120	343	18.6	39	328	762
		40	2.9	41	51	132	4.2	41	37	189	9.3	41	100	421
	50	30	5.8	32	95	179	8.4	33	73	267	18.6	33	199	593
		45	35	2.9	36	32	104	4.2	36	23	150	9.3	36	63
55	50	40	2.9	41	95	179	4.2	41	67	257	9.3	41	185	571
		30	5.8	35	186	250	8.4	34	120	343	18.6	35	362	800
	45	35	2.9	36	51	132	4.2	36	37	189	9.3	36	100	421

sec	dp	125 mbar	130 mbar	175 mbar
	res. Pump head	85 mbar	95 mbar	100 mbar
	q	250 kg/h	360 kg/h	800 kg/h

FLOW AND PRESSURE LOSS DIAGRAMS PLATE HEAT EXCHANGER WITH 10, 16 AND 26 PLATES (HEATING MODULE)

Heating secondary Performance

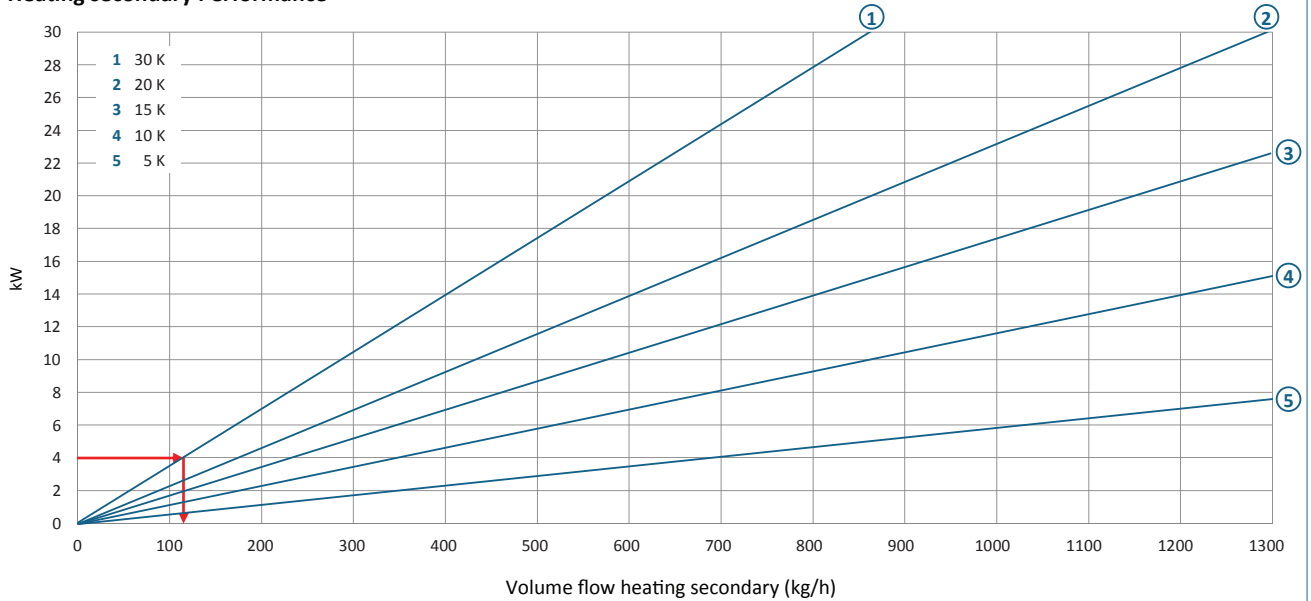

Heating secondary: Pump Curve / Pressure loss

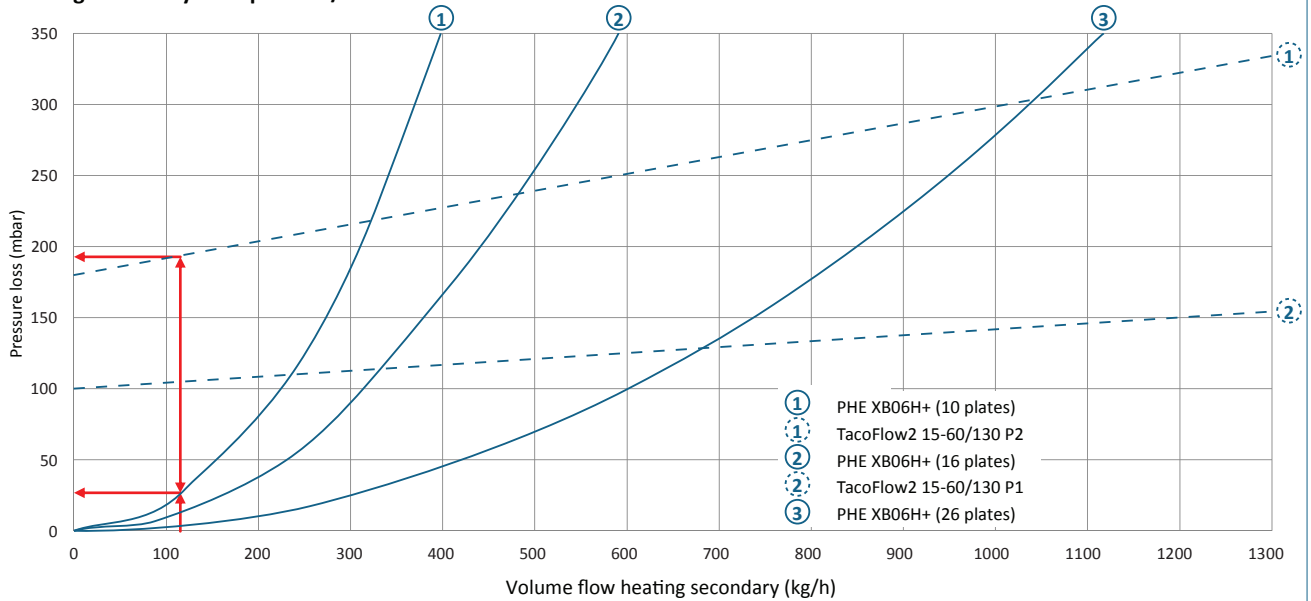

C Pressure loss primary (with FlowCon DPCV heatmeter)

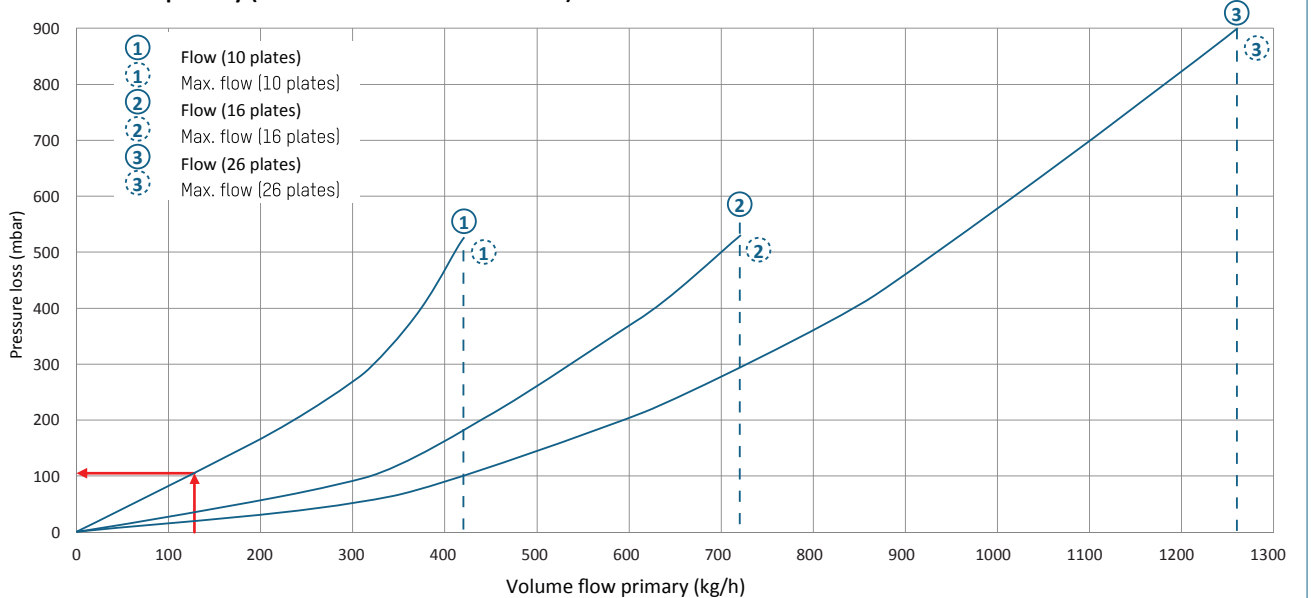

ACCESSORIES

Set of pipes

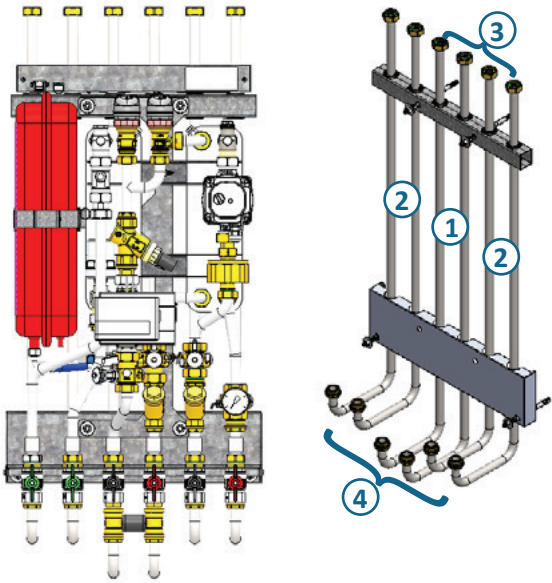

- 1 295.0004.696 | Pipeset top 1: prim. heating
- 2 295.0005.696 | Pipeset top 2: sec. DHW or sec. heating
- 3 295.0006.696 | Pipeset top 3: prim. heating + sec DHW or sec heating
- 4 295.0007.696 | Pipeset top 4: all connections

Fixrail including flushing Bypass

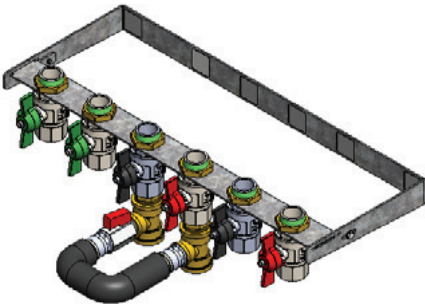

296.0100.696 | Fixrail including flushing bypass

ACCESSORIES

Part no.	Description
W1-FFR-FBV	Fixrail including flushing bypass
W1-PKIT-2	Pipeset top 1: prim. heating
W1-PKIT-2	Pipeset top 2: sec. DHW or sec. heating
W1-PKIT-3	Pipeset top 3: prim. heating + sec DHW or sec heating
W1-PKIT-4	Pipeset top 4: all connections
W1-HMI-Z1	HMI for Z1 Controller

OPTIONS

Part no.	Description
W1-NO-HM	No Heatmeter
W1-WCV	White Frontcover (on request: metal sheet cover)
W1-HF-DPCV	Hi-Flow DPCV
W1-DCW-SF	Safety Valve DCW
W1-FL	Flow limiters
W1-FFR-ENC	Fixrail enclosure